

**DASCH on KU Cyg:
a 5 year dust accretion event in ~1900**

Sumin Tang

Jonathan Grindlay, Edward Los, Mathieu Servillat

Harvard-Smithsonian Center for Astrophysics

AAS 218th Meeting, Boston, May 23, 2011

Introduction to DASCH

Digital Access to a Sky Century@Harvard

Digitize and Measure the Harvard Plates
to open the ~100yr TD Window

- ~530,000 photographic plates between 1880s-1980s covering the whole sky (*Grindlay et al. 2009*).
- ~500-1500 measurements for each object with $B \sim 10-14$ (up to 18 mag in some regions)
- Study temporal variations of a wide variety of objects (stars to AGNs)
- Astrometry: 0.8-3 arcsec
Photometry: 0.1-0.15 mag (*Laycock et al. 2010*).



RA-Dec map of scanned plates:

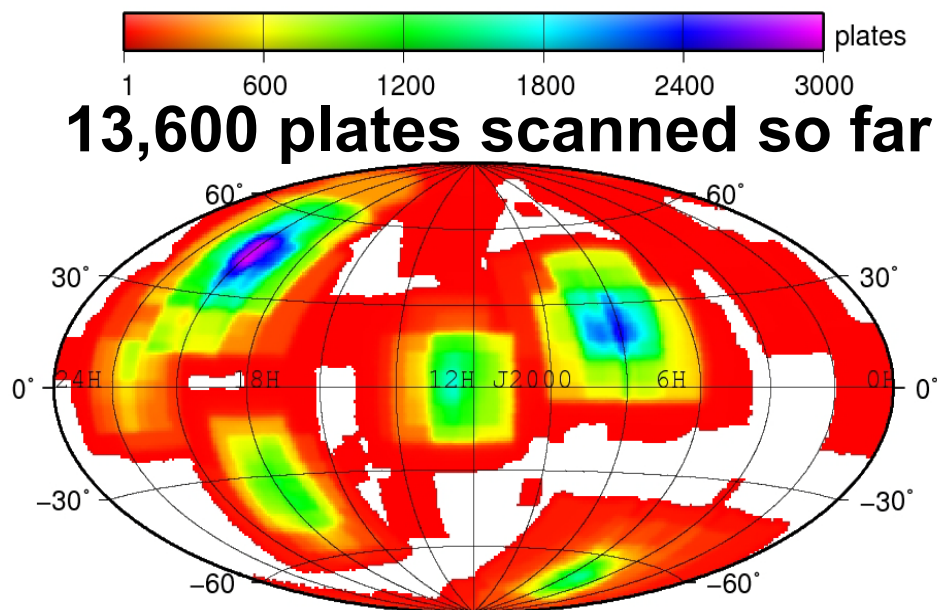

KU Cyg

Popper 1964, 1965; Olson 1988;
Olson et al. 1995; Smak & Plavec 1997

0.48 M_{\odot} K5III Roche lobe filling
3.85 M_{\odot} F MS star with accretion disk

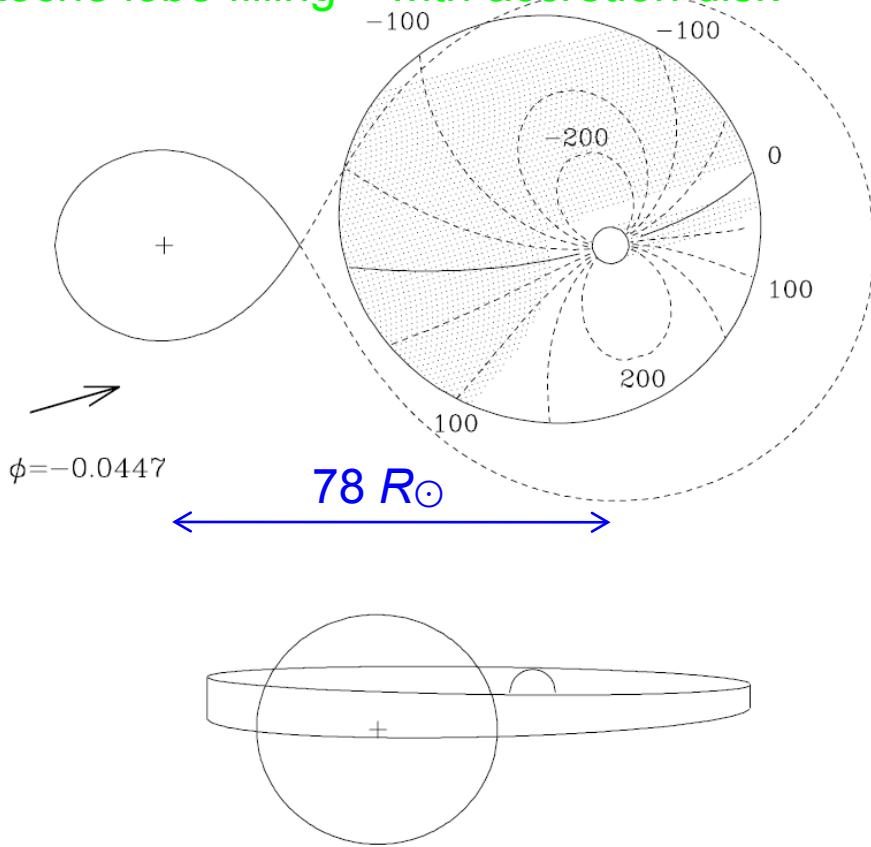

Smak & Plavec 1997

- Algol-type eclipsing binary
- 3.85 M_{\odot} F MS star + 0.48 M_{\odot} K5III
- Large, thick and dusty accretion disk around the F star: $\sim 10^{-8}$ - $10^{-5} M_{\odot}$
- Peak accretion rate: $\sim 10^{-6} M_{\odot}/\text{yr}$
- Accretion timescale: a few years
- $P=38.439484$ days, $i=86$ - 86.5 deg
- Extinction of the F star due to the disk: ~ 1.3 mag (Smak & Plavec 1997)

Broad wing in primary eclipse:
disk behind the K5III

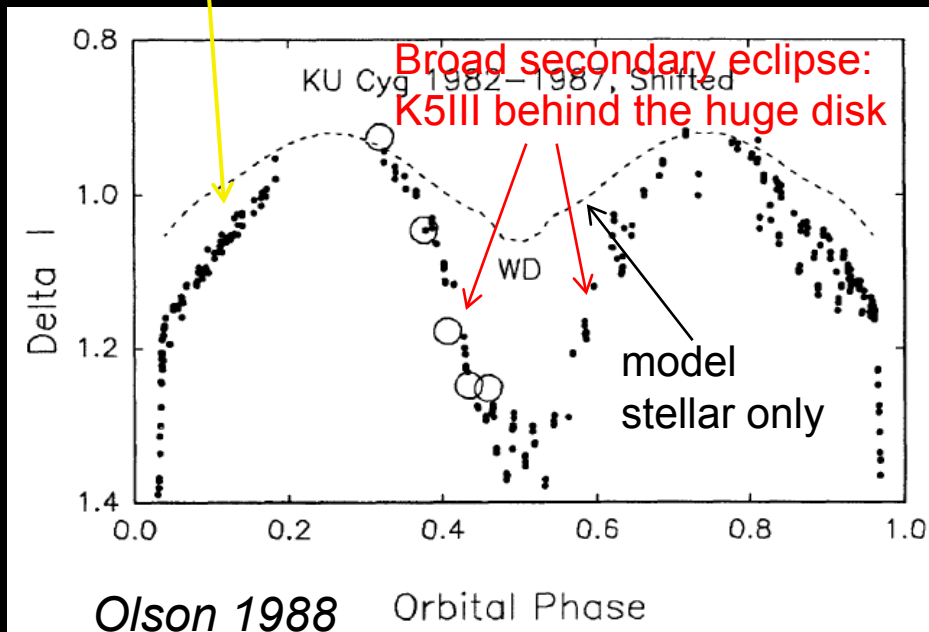

Olson 1988 Orbital Phase

DASCH light curve of KU Cyg

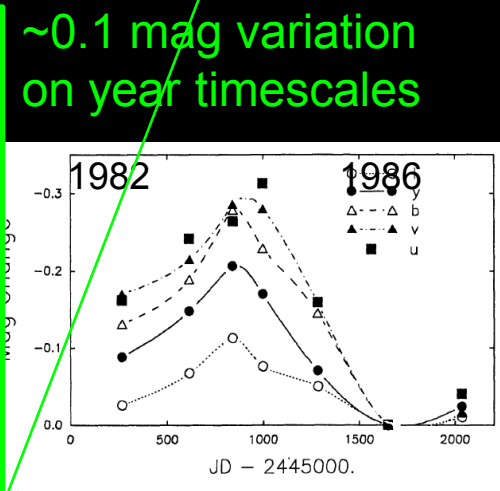
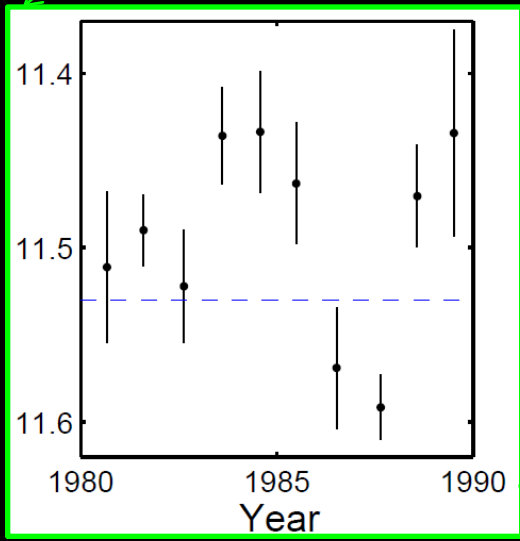
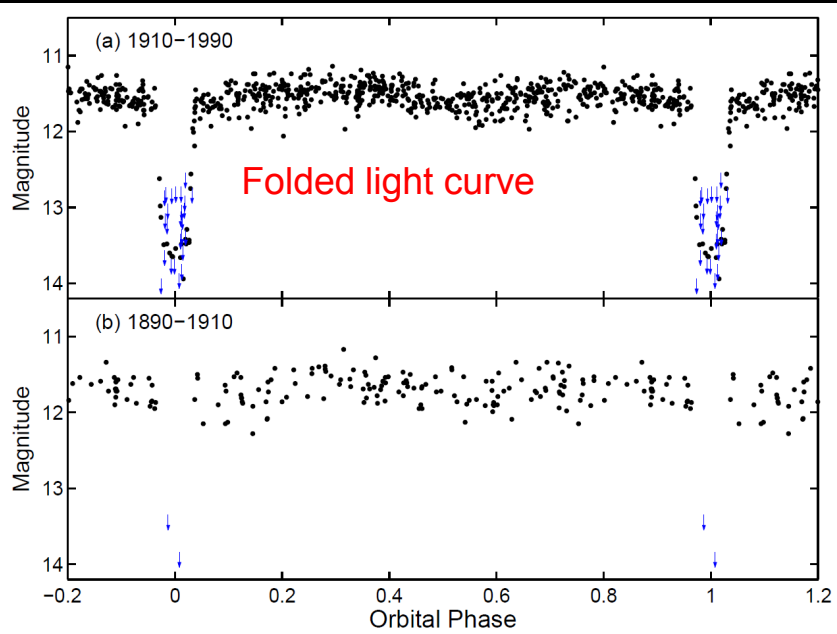
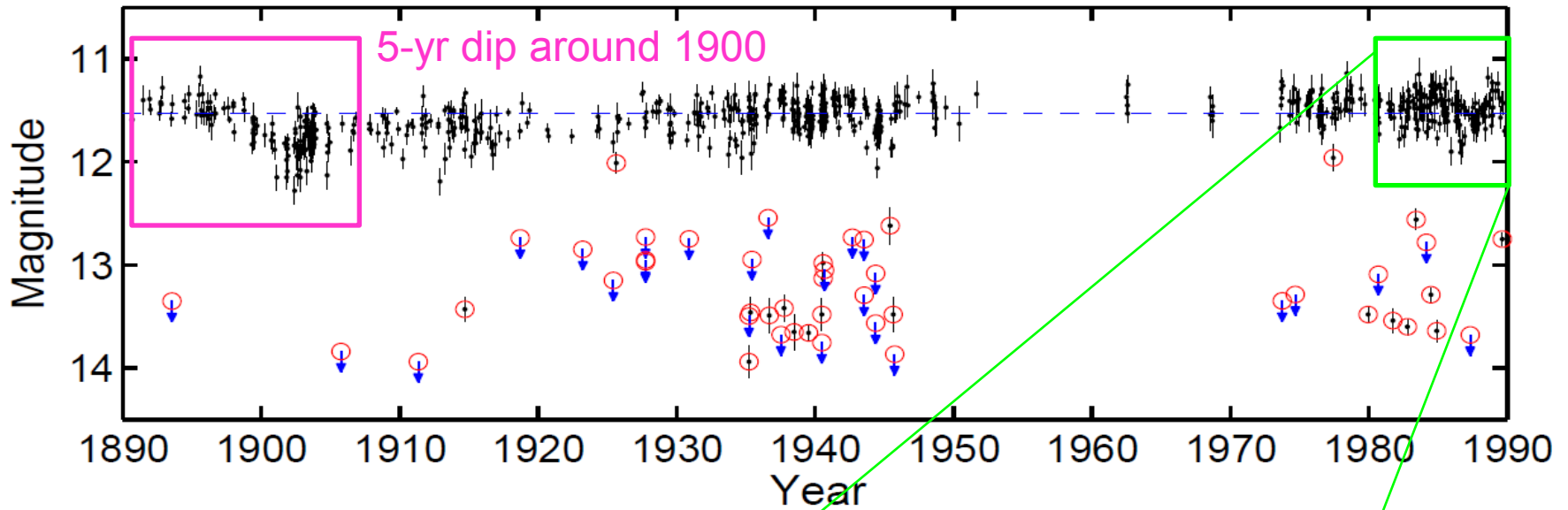

Olson 1988

5-yr dip around 1900

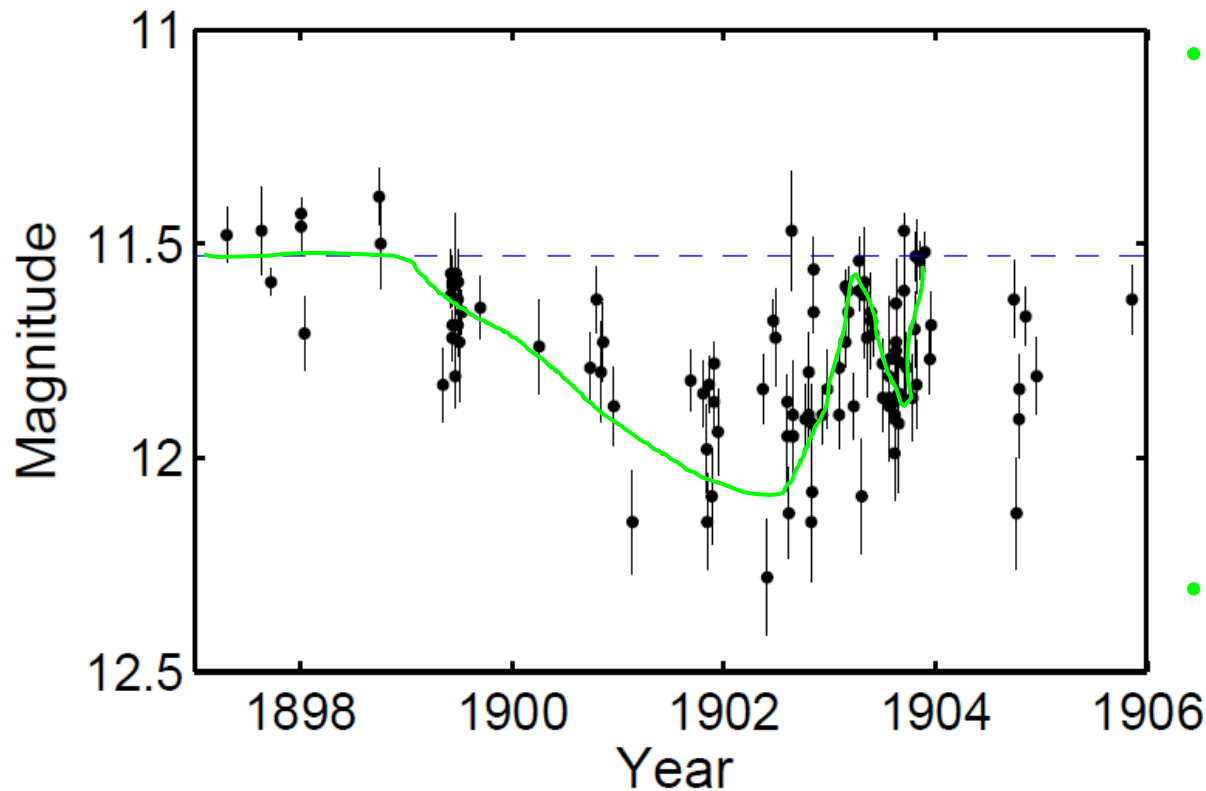

- Faded slowly and brightened back relatively fast with oscillations

Different from dust production & dispersion process as observed in RCB stars

- $P=38.4$ days + K5III contributes $<10\%$ L: must be related to the F star and its accretion disk

AAVSO DATA FOR R CRB - WWW.AAVSO.ORG

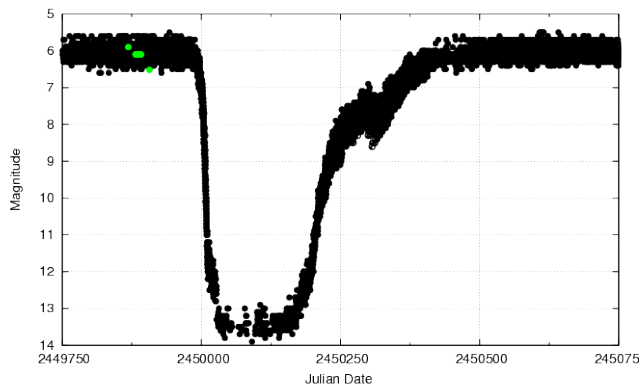

RCB@AAVSO:

faster fading, slower recovery
b/c it usually takes short time to produce dust,
and longer time for the dust to get dispersed

Possible explanation of the 5-yr dip:

increasing disk extinction of the F star arising from increasing mass transfer rate and thus higher disk mass

Fading:

- Increased disk mass and consequently increased optical depth, leading to increased attenuation
- Given the 1.3 mag extinction (0.7 mag blocking + 0.6 mag absorption by disk atmosphere) by the disk in normal state (Smack & Plavec 1997), double the original disk mass could yield a ~0.5-0.6 mag dimming

Brightening and fluctuations:

- Dust evaporates when moves closer to the F star -> **brightening**
- Some evaporated dust transported outwards, cool down to condensate (~1500 K), more extinction -> **fading**
- Energy release on the boundary layer when accreted on the F star
-> **brightening**

Or higher dust to gas ratio?

- Dust clumps are ejected from K giants (*Tang et al. 2010*), so the dimming could be simply due to such an ejection from the K giant in this binary

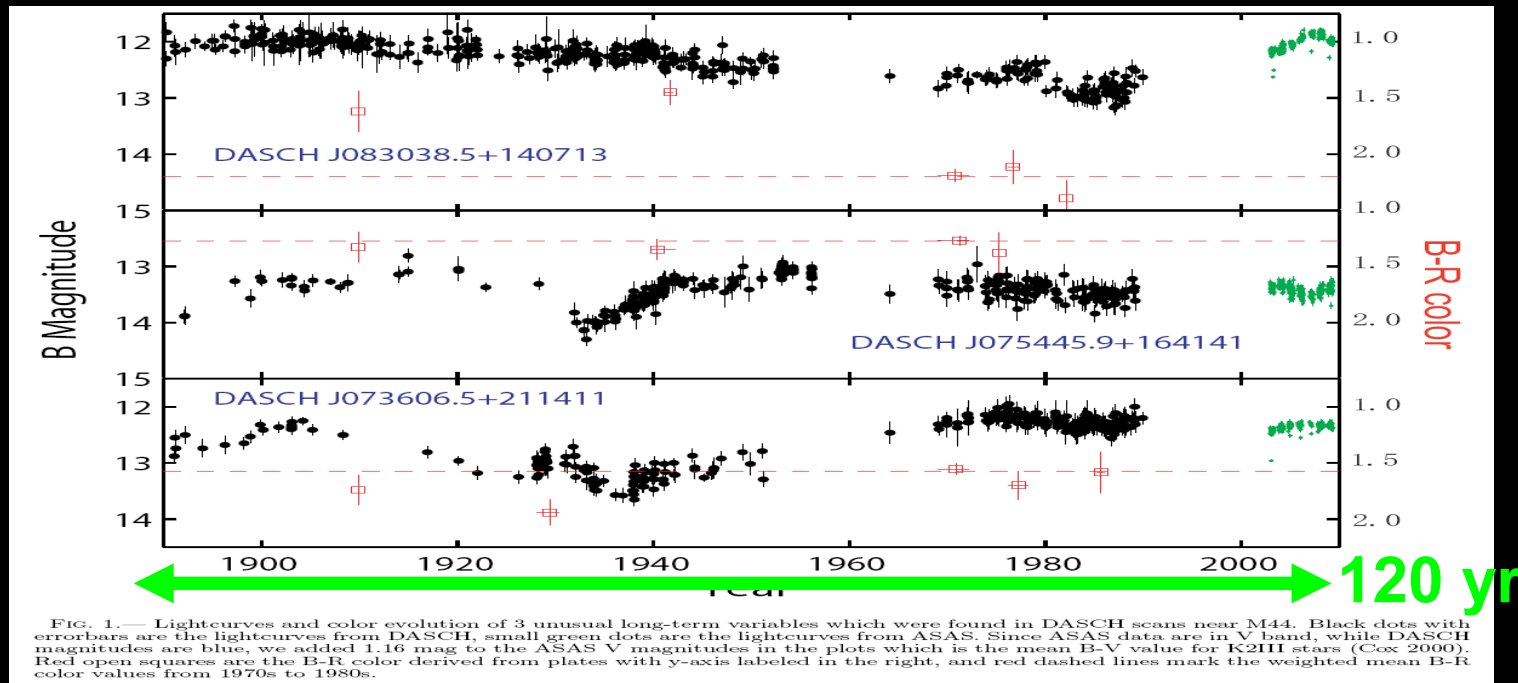

- Disruption of a 20 km-size comet
Very unlikely origin but cannot be ruled out
- **Rapid rise:** dust moves in through the disk and is evaporated as it approaches the hot star

Summary

- We discovered a 5 year dip of KU Cyg around 1900, which is unique in the way that it faded slowly and brightened back relatively fast
- This fading-brightening event in KU Cyg is probably related to the accretion disk surrounding the F star, which provides interesting clue for the study of dust confinement, levitation and evaporation in an accretion disk.

The power of DASCH: 100 yr light curves of $B < 15$ objects

- Explore long-term variability for known variables
- Discovery of exciting new types of variables